

AV28WT5EPS AV24WT5EPS
AV28WT5EIS AV24WT5EIS
AV28WT5EKS AV24WT5EKS

JVC

SERVICE MANUAL

COLOUR TELEVISION

BASIC CHASSIS

JK II

AV28WT5EPS AV24WT5EPS
AV28WT5EIS AV24WT5EIS
AV28WT5EKS AV24WT5EKS

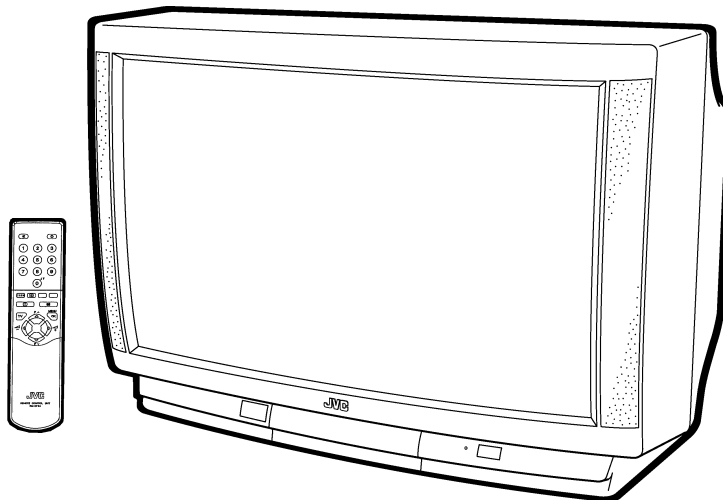

CONTENTS

■ SPECIFICATIONS	2
■ SAFETY PRECAUTIONS	4
■ WARNING	5
■ FEATURES	7
■ MAIN DIFFERENCE PARTS LIST	9
■ SPECIFIC SERVICE INSTRUCTIONS	10
■ SERVICE ADJUSTMENTS	17
■ PARTS LIST	39
★ OPERATING INSTRUCTIONS	1-1
★ STANDARD CIRCUIT DIAGRAM	2-1

SPECIFICATIONS (28" Model)

Item	Content		
	AV28WT5EPS	AV28WT5EIS	AV28WT5EKS
Dimensions (W × H × D) Mass	716mm × 489mm × 496mm 34.2kg	← ←	← ←
TV RF System	CCIR (B/G, I, L)	CCIR (I)	CCIR (I)
Colour System	PAL / SECAM / NTSC (Only in EXT mode)	PAL / NTSC (Only in EXT mode)	PAL / NTSC (Only in EXT mode)
Stereo System	A2 / NICAM	NICAM	NICAM
Teletext System	FLOF (Fastext) TOP (German system) WST(Standard system)	FLOF (Fastext) WST(Standard system)	←
Receiving Frequency			
VHF	47MHz ~ 470MHz	47MHz ~ 470MHz	_____
UHF	470MHz ~ 862MHz	470MHz ~ 862MHz	470MHz ~ 862MHz
French CATV	116MHz ~ 172MHz / 220MHz ~ 469MHz	_____	_____
Intermediate Frequency			
VIF Carrier	38.9MHz (B/G, I, L) / 33.95MHz (L')	38.9MHz (I)	38.9MHz (I)
SIF Carrier	33.4MHz (5.5MHz:B/G) / 32.9MHz (6.0MHz:I) / 32.4MHz (6.5MHz:L) / 27.45MHz (6.5MHz:L')	32.9MHz (6.0MHz:I)	32.9MHz (6.0MHz:I)
Colour Sub Carrier Freq.			
PAL	4.43MHz	4.43MHz	4.43MHz
SECAM	4.40625MHz / 4.25MHz	_____	_____
NTSC	3.58MHz / 4.43MHz	3.58MHz / 4.43MHz	3.58MHz / 4.43MHz
Power Input	AC 220V~240V , 50Hz	←	←
Power Consumption	156W(Max) / 122W(Avg), 122W/h(ITALY)	_____	_____
Aerial Input Term	75 Ω unbalanced, Coaxial	←	←
Picture Tube	Visible size : 66cm, Measured diagonally		
High Voltage	30.0kV +1kV -1.5kV (at zero beam current)	←	←
Speaker	10cm × 3cm Oval type × 2	←	←
Audio Output	5W + 5W		
EXT-1/EXT-2/EXT-3 (Input / Output)	21-pin Euro connector (SCART socket)	←	←
EXT-4 (Input)	Video 1Vp-p 75 Ω (RCA pin jack) Audio(L/R) 500mVrms(-4dBs), High Impedance (RCA pin jack) S / Video Y : 1Vp-p POSITIVE (Negative sync Provided, when terminated with 75 Ω) C : 0.286Vp-p (Burst signal, when terminated with 75 Ω)	←	←
AUDIO OUT (Variable)	0~1Vrms, Low Impedance (RCA pin jack × 2)	←	←
Headphone jack	Stereo mini jack (φ 3.5mm)		
Remote Control Unit	RM-C54 (AAA/R03 dry battery × 2)	RM-C55 (AAA/R03 dry battery × 2)	←

Design & specifications are subject to change without notice.

SPECIFICATIONS (24" Model)

Item	Content		
	AV24WT5EPS	AV24WT5EIS	AV24WT5EKS
Dimensions (W × H × D) Mass	645mm × 427mm × 443mm 23.1kg	← ←	← ←
TV RF System	CCIR (B/G, I, L)	CCIR (I)	←
Colour System	PAL / SECAM / NTSC (Only in EXT mode)	PAL / NTSC (Only in EXT mode)	←
Stereo System	A2 / NICAM	NICAM	←
Teletext System	FLOF (Fastext) TOP (German system) WST(Standard system)	FLOF (Fastext) WST(Standard system)	←
Receiving Frequency VHF UHF French CATV	47MHz ~ 470MHz 470MHz ~ 862MHz 116MHz ~ 172MHz / 220MHz ~ 469MHz	47MHz ~ 470MHz 470MHz ~ 862MHz _____	 470MHz ~ 862MHz _____
Intermediate Frequency VIF Carrier SIF Carrier	38.9MHz (B/G, I, L) / 33.95MHz (L') 33.4MHz (5.5MHz:B/G) / 32.9MHz (6.0MHz:I) / 32.4MHz (6.5MHz:L) / 27.45MHz (6.5MHz:L')	38.9MHz (I) 32.9MHz (6.0MHz:I)	← ←
Colour Sub Carrier Freq. PAL SECAM NTSC	4.43MHz 4.40625MHz / 4.25MHz 3.58MHz / 4.43MHz	4.43MHz 3.58MHz / 4.43MHz	← ←
Power Input Power Consumption	AC 220V ~ 240V , 50Hz 127W(Max) / 92W(Avg) 92W/h(ITALY)	← ← _____	← ← _____
Aerial Input Term	75 Ω unbalanced, Coaxial		
Picture Tube High Voltage	Visible size : 56cm, Measured diagonally +1kV 30.0kV -1.5kV (at zero beam current)	← ←	← ←
Speaker Audio Output	10cm × 3cm Oval type × 2 5W + 5W	← ←	← ←
EXT-1/EXT-2/EXT-3 (Input / Output)	21-pin Euro connector (SCART socket)	←	←
EXT-4 (Input) Video Audio(L/R) S / Video	1Vp-p 75 Ω (RCA pin jack) 500mVrms(-4dBs), High Impedance (RCA pin jack) Y : 1Vp-p POSITIVE (Negative sync Provided, when terminated with 75 Ω) C : 0.286Vp-p (Burst signal, when terminated with 75 Ω)	←	←
AUDIO OUT Headphone jack	0~1Vrms, Low Impedance (RCA pin jack) Stereo mini jack (φ 3.5mm)	← ←	← ←
Remote Control Unit	RM-C54 (AAA/R03 dry battery × 2)	RM-C55 (AAA/R03 dry battery × 2)	←

Design & specifications are subject to change without notice

SAFETY PRECAUTIONS

AV28WT5EPS / AV24WT5EPS

- The design of this product contains special hardware, many circuits and components specially for safety purposes. For continued protection, no changes should be made to the original design unless authorized in writing by the manufacturer. Replacement parts must be identical to those used in the original circuits. Service should be performed by qualified personnel only.
- Alterations of the design or circuitry of the products should not be made. Any design alterations or additions will void the manufacturer's warranty and will further relieve the manufacturer of responsibility for personal injury or property damage resulting therefrom.
- Many electrical and mechanical parts in the products have special safety-related characteristics. These characteristics are often not evident from visual inspection nor can the protection afforded by them necessarily be obtained by using replacement components rated for higher voltage, wattage, etc. Replacement parts which have these special safety characteristics are identified in the parts list of Service manual. **Electrical components having such features are identified by shading on the schematics and by (Δ) on the parts list in Service manual.** The use of a substitute replacement which does not have the same safety characteristics as the recommended replacement part shown in the parts list of Service manual may cause shock, fire, or other hazards.
- Don't short between the LIVE side ground and ISOLATED (NEUTRAL) side ground or EARTH side ground when repairing.**
Some model's power circuit is partly different in the GND. The difference of the GND is shown by the LIVE : (\perp) side GND, the ISOLATED(NEUTRAL) : (\neq) side GND and EARTH : (\oplus) side GND. Don't short between the LIVE side GND and ISOLATED(NEUTRAL) side GND or EARTH side GND and never measure with a measuring apparatus (oscilloscope etc.) the LIVE side GND and ISOLATED(NEUTRAL) side GND or EARTH side GND at the same time.
If above note will not be kept, a fuse or any parts will be broken.
- If any repair has been made to the chassis, it is recommended that the B1 setting should be checked or adjusted (See ADJUSTMENT OF B1 POWER SUPPLY).
- The high voltage applied to the picture tube must conform with that specified in Service manual. Excessive high voltage can cause an increase in X-Ray emission, arcing and possible component damage, therefore operation under excessive high voltage conditions should be kept to a minimum, or should be prevented. If severe arcing occurs, remove the AC power immediately and determine the cause by visual inspection (incorrect installation, cracked or melted high voltage harness, poor soldering, etc.). To maintain the proper minimum level of soft X-Ray emission, components in the high voltage circuitry including the picture tube must be the exact replacements or alternatives approved by the manufacturer of the complete product.
- Do not check high voltage by drawing an arc. Use a high voltage meter or a high voltage probe with a VTVM. Discharge the picture tube before attempting meter connection, by connecting a clip lead to the ground frame and connecting the other end of the lead through a 10k Ω 2W resistor to the anode button.
- When service is required, observe the original lead dress. Extra precaution should be given to assure correct lead dress in the high voltage circuit area. Where a short circuit has occurred, those components that indicate evidence of overheating should be replaced. Always use the manufacturer's replacement components.

9. Isolation Check

(Safety for Electrical Shock Hazard)

After re-assembling the product, always perform an isolation check on the exposed metal parts of the cabinet (antenna terminals, video/audio input and output terminals, Control knobs, metal cabinet, screwheads, earphone jack, control shafts, etc.) to be sure the product is safe to operate without danger of electrical shock.

(1) Dielectric Strength Test

The isolation between the AC primary circuit and all metal parts exposed to the user, particularly any exposed metal part having a return path to the chassis should withstand a voltage of 3000V AC (r.m.s.) for a period of one second.

(. . . Withstand a voltage of 1100V AC (r.m.s.) to an appliance rated up to 120V, and 3000V AC (r.m.s.) to an appliance rated 200V or more, for a period of one second.)

This method of test requires a test equipment not generally found in the service trade.

(2) Leakage Current Check

Plug the AC line cord directly into the AC outlet (do not use a line isolation transformer during this check.). Using a "Leakage Current Tester", measure the leakage current from each exposed metal part of the cabinet, particularly any exposed metal part having a return path to the chassis, to a known good earth ground (water pipe, etc.). Any leakage current must not exceed 0.5mA AC (r.m.s.).

However, in tropical area, this must not exceed 0.2mA AC (r.m.s.).

● Alternate Check Method

Plug the AC line cord directly into the AC outlet (do not use a line isolation transformer during this check.). Use an AC voltmeter having 1000 ohms per volt or more sensitivity in the following manner. Connect a 1500 Ω 10W resistor paralleled by a 0.15 μ F AC-type capacitor between an exposed metal part and a known good earth ground (water pipe, etc.). Measure the AC voltage across the resistor with the AC voltmeter. Move the resistor connection to each exposed metal part, particularly any exposed metal part having a return path to the chassis, and measure the AC voltage across the resistor. Now, reverse the plug in the AC outlet and repeat each measurement. Any voltage measured must not exceed 0.75V AC (r.m.s.). This corresponds to 0.5mA AC (r.m.s.).

However, in tropical area, this must not exceed 0.3V AC (r.m.s.). This corresponds to 0.2mA AC (r.m.s.).

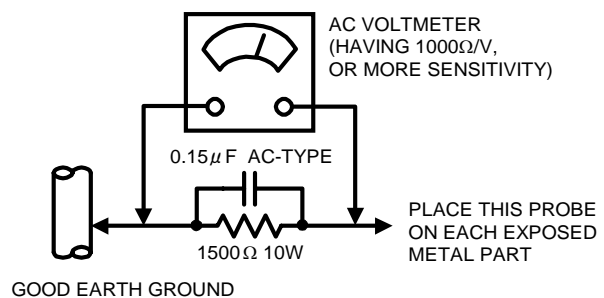

SAFETY PRECAUTIONS

**AV28WT5EIS / AV24WT5EIS
AV28WT5EKS / AV24WT5EKS**

1. The design of this product contains special hardware and many circuits and components specially for safety purposes. For continued protection, no changes should be made to the original design unless authorized in writing by the manufacturer. Replacement parts must be identical to those used in the original circuits. Service should be performed by qualified personnel only.
2. Alterations of the design or circuitry of the product should not be made. Any design alterations or additions will void the manufacturer's warranty and will further relieve the manufacturer of responsibility for personal injury or property damage resulting therefrom.
3. Many electrical and mechanical parts in the product have special safety-related characteristics. These characteristics are often not evident from visual inspection nor can the protection afforded by them necessary be obtained by using replacement components rated for higher voltage, wattage, etc. Replacement parts which have these special safety characteristics are identified in the Parts List of Service Manual. Electrical components having such features are identified by shading on the schematics and by (Δ) on the Parts List in the Service Manual. The use of a substitute replacement which does not have the same safety characteristics as the recommended replacement part shown in the Parts List of Service Manual may cause shock, fire, or other hazards.
4. The leads in the products are routed and dressed with ties, clamps, tubing's, barriers and the like to be separated from live parts, high temperature parts, moving parts and / or sharp edges for the prevention of electric shock and fire hazard. When service is required, the original lead routing and dress should be observed, and it should be confirmed that they have been returned to normal, after re-assembling.

WARNING

1. The equipment has been designed and manufactured to meet international safety standards.
2. It is the legal responsibility of the repairer to ensure that these safety standards are maintained.
3. Repairs must be made in accordance with the relevant safety standards.
4. It is essential that safety critical components are replaced by approved parts.
5. If mains voltage selector is provided, check setting for local voltage.

AV28WT5EPS AV24WT5EPS
 AV28WT5EIS AV24WT5EIS
 AV28WT5EKS AV24WT5EKS

■21-pin Euro connector (SCART socket) : EXT-1 / EXT-2 / EXT-3

(P-P= Peak to Peak, S-W= Sync tip to white peak, B-W= Blanking to white peak)

Pin No.	Signal Designation	Matching Value	EXT-1	EXT-2	EXT-3
1	AUDIO R output	500mVrms(Nominal), Low impedance	○ (TV OUT)	○ (LINE OUT)	NC
2	AUDIO R input	500mVrms(Nominal), High impedance	○	○	○
3	AUDIO L output	500mVrms(Nominal), Low impedance	○ (TV OUT)	○ (LINE OUT)	NC
4	AUDIO GND		○	○	○
5	GND (B)		○	○	○
6	AUDIO L input	500mVrms(Nominal), High impedance	○	○	○
7	B input	700mV _{B-W} , 75Ω	○	NC	NC
8	FUNCTION SW (SLOW SW)	Low : 0-3V, High : 8-12V, High impedance	○	○	○
9	GND (G)		○	○	○
10	SCL3		NC	○	NC
11	G input	700mV _{B-W} , 75Ω	○	NC	NC
12	SDA3		NC	○	NC
13	GND (R)		○	○	○
14	GND (Y _S)		○	NC	NC
15	R / C input	R : 700mV _{B-W} , 75Ω C : 300mV _{P-P} , 75Ω	○ (only R)	○ (only C)	○ (only C)
16	Ys input	Low : 0 - 0.4, High : 1 - 3V, 75Ω	○	NC	NC
17	GND(VIDEO output)		○	○	○
18	GND(VIDEO input)		○	○	○
19	VIDEO output	1V _{P-P} (Negative going sync), 75Ω	○ (TV)	○ (LINE OUT)	NC
20	VIDEO / Y input	1V _{P-P} (Negative going sync), 75Ω	○	○	○
21	COMMON GND		○	○	○

[Pin assignment]

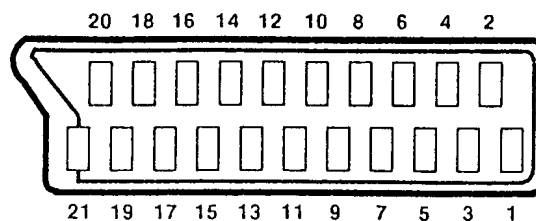

FEATURES

- By preference, users can select the picture size from REGULAR, PANORAMIC, FULL, 14:9 ZOOM, 16:9 ZOOM, 16:9 ZOOM SUB TITLE modes. When the TV unit received WSS picture signal, the picture can be changed to 16:9 ZOOM mode automatically.
- The TELETEXT SYSTEM has a built-in FASTEXT, TOP(Only AV28WT5EPS / AV24WT5EPS) and WST system.
- Because this TV unit corresponds to multiplex broadcast, users can enjoy music programs and sporting events with live realism. In addition, BILINGUAL programs can be heard in their original language.
- Built-in ECO (ECONOMY, ECOLOGY) MODE.
In accordance with the brightness in a room, the brightness and/or contrast of the picture can be adjusted automatically to make the optimum picture which is easy on the eye.
- Users can make VCR dubbing of picture and sound by controlling the AV selector to select an optional source at the EXT-2 output shown in figure.

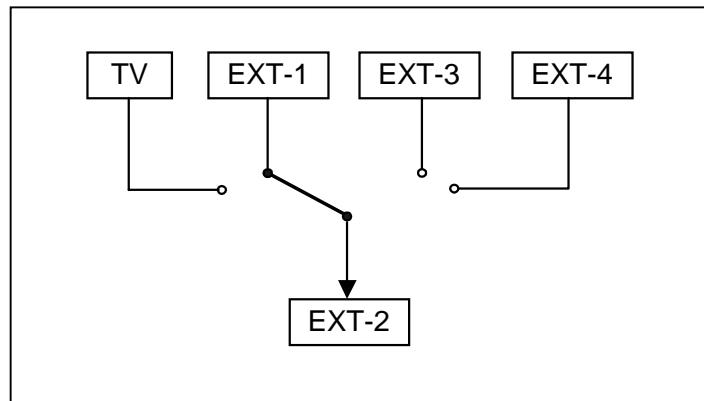

AV28WT5EPS AV24WT5EPS
 AV28WT5EIS AV24WT5EIS
 AV28WT5EKS AV24WT5EKS

MAIN DIFFERENCE PARTS LIST

(28" Model)

△	Model Name		AV28WT5EPS	AV28WT5EIS	AV28WT5EKS
	Part Name				
	MAIN PWB		SJK-1712A-U2	←	SJK-1912A-U2
	AV SEL. PWB		SJK0S712A-U2	←	SJK0S912A-U2
△	POWER CORD		QMPK160-185-JC	QMPN130-185-JC	←
△	RATING LABEL		LC20433-008A-U LC20434-008A-U	LC20080-015A-U	LC20091-023A-U
	EURO LABEL		AEM1052-031-E	AEM1052-030-E	AEM1052-029-E
△	INST BOOK		LCT0897-001A-U LCT0898-001A-U	LCT0900-001A-U	LCT0899-001A-U
	REMOTE CONTROL UNIT		RM-C54-1C	RM-C55-1C	←
	X-RAY CARD		AEM1061-001-E	×	×
	S. DIAGRAM ONLY ITALY(SERVICE)		2824WT5-HSAEI	×	×
	REG. SHEET		×	×	AEM3148-001-E

(24" Model)

△	Model Name		AV24WT5EPS	AV24WT5EIS	AV24WT5EKS
	Part Name				
	MAIN PWB		SJK-1713A-U2	←	SJK-1913A-U2
	AV SEL. PWB		SJK0S713A-U2	←	SJK0S913A-U2
△	POWER CORD		QMPK160-185-JC	QMPN130-185-JC	←
△	RATING LABEL		LC20433-007A-U LC20434-007A-U	LC20080-014A-U	LC20091-022A-U
	EURO LABEL		AEM1052-027-E	AEM1052-025-E	AEM1052-026-E
△	INST BOOK		LCT0897-001A-U LCT0898-001A-U	LCT0900-001A-U	LCT0899-001A-U
	REMOTE CONTROL UNIT		RM-C54-1C	RM-C55-1C	←
	X-RAY CARD		AEM1060-001-E	×	×
	S. DIAGRAM ONLY ITALY(SERVICE)		2824WT5-HSAEI	×	×
	REG. SHEET		×	×	AEM3148-001-E

SPECIFIC SERVICE INSTRUCTIONS

REPLACEMENT OF CHIP COMPONENT

■ CAUTIONS

1. Avoid heating for more than 3 seconds.
2. Do not rub the electrodes and the resist parts of the pattern.
3. When removing a chip part, melt the solder adequately.
4. Do not reuse a chip part after removing it.

■ SOLDERING IRON

1. Use a high insulation soldering iron with a thin pointed end of it.
2. A 30w soldering iron is recommended for easily removing parts.

■ REPLACEMENT STEPS

1. How to remove Chip parts

◆ Resistors, capacitors, etc

- (1) As shown in the figure, push the part with tweezers and alternately melt the solder at each end.

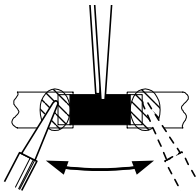

- (2) Shift with tweezers and remove the chip part.

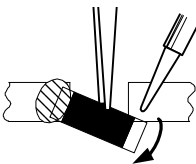

◆ Transistors, diodes, variable resistors, etc

- (1) Apply extra solder to each lead.

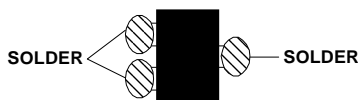

- (2) As shown in the figure, push the part with tweezers and alternately melt the solder at each lead. Shift and remove the chip part.

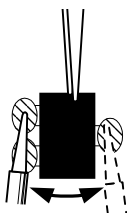

Note : After removing the part, remove remaining solder from the pattern.

2. How to install Chip parts

◆ Resistors, capacitors, etc

- (1) Apply solder to the pattern as indicated in the figure.

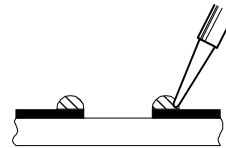

- (2) Grasp the chip part with tweezers and place it on the solder. Then heat and melt the solder at both ends of the chip part.

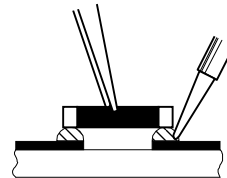

◆ Transistors, diodes, variable resistors, etc

- (1) Apply solder to the pattern as indicated in the figure.
- (2) Grasp the chip part with tweezers and place it on the solder.
- (3) First solder lead **A** as indicated in the figure.

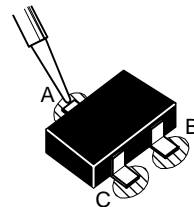

- (4) Then solder leads **B** and **C**.

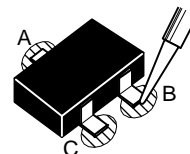

DISASSEMBLY PROCEDURE (28" Model)

REMOVING THE REAR COVER

1. Unplug the power cord.
2. Remove the 13 screws marked "A" as shown in the Fig. 1.
3. Withdraw the rear cover toward you.

REMOVING THE CHASSIS

- After removing the rear cover.
1. Remove the screw marked "B" on the S/VIDEO terminal of FRONT CABINET as shown in the Fig. 1.
 2. Slightly raise the both sides of the chassis by hand and remove the two claws under the both sides of the chassis from the front cabinet.
 3. Withdraw the chassis backward.
(If necessary, take off the wire clamp, connectors etc.)

REMOVING THE AV TERMINAL BOARD

- After removing the rear cover.
1. Remove the 2 screws marked "C" as shown in the Fig. 1.
 2. Remove the claws marked "D" under the CHASSIS as shown in Fig. 2.
 3. While raising the claw marked "E", remove the top of the AV TERMINAL BOARD slightly in the direction of arrow "F" as shown in Fig. 2.

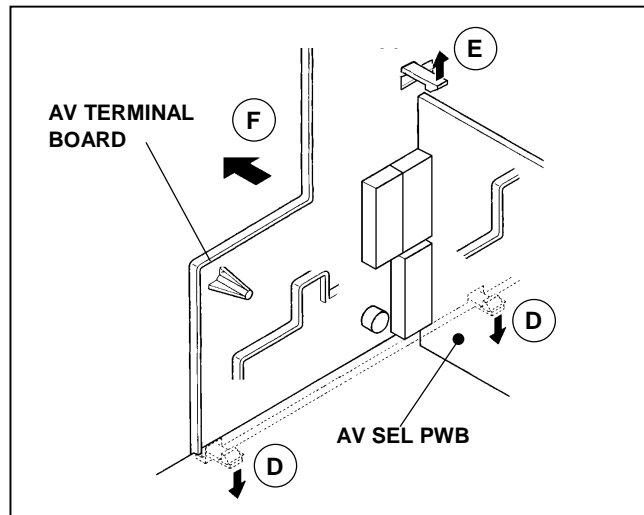

Fig. 2

REMOVING THE SPEAKER

- After removing the rear cover.
1. Remove the 2 screws marked "G" as shown in Fig. 1.
 2. Follow the same steps when removing the other hand speaker.

CHECKING THE PW BOARD

To check the back side of the PW Board.

- 1) Pull out the chassis. (Refer to REMOVING THE CHASSIS).
- 2) Erect the chassis vertically so that you can easily check the back side of the PW Board.

[CAUTION]

- When erecting the chassis, be careful so that there will be no contacting with other PW Board.
- Before turning on power, make sure that the wire connector is properly connected.
- When conducting a check with power supplied, be sure to confirm that the CRT EARTH WIRE (BRAIDED ASS'Y) is connected to the CRT SOCKET PW board.

WIRE CLAMPING AND CABLE TYING

1. Be sure to clamp the wire.
2. Never remove the cable tie used for tying the wires together.
Should it be inadvertently removed, be sure to tie the wires with a new cable tie.

(28" Model)

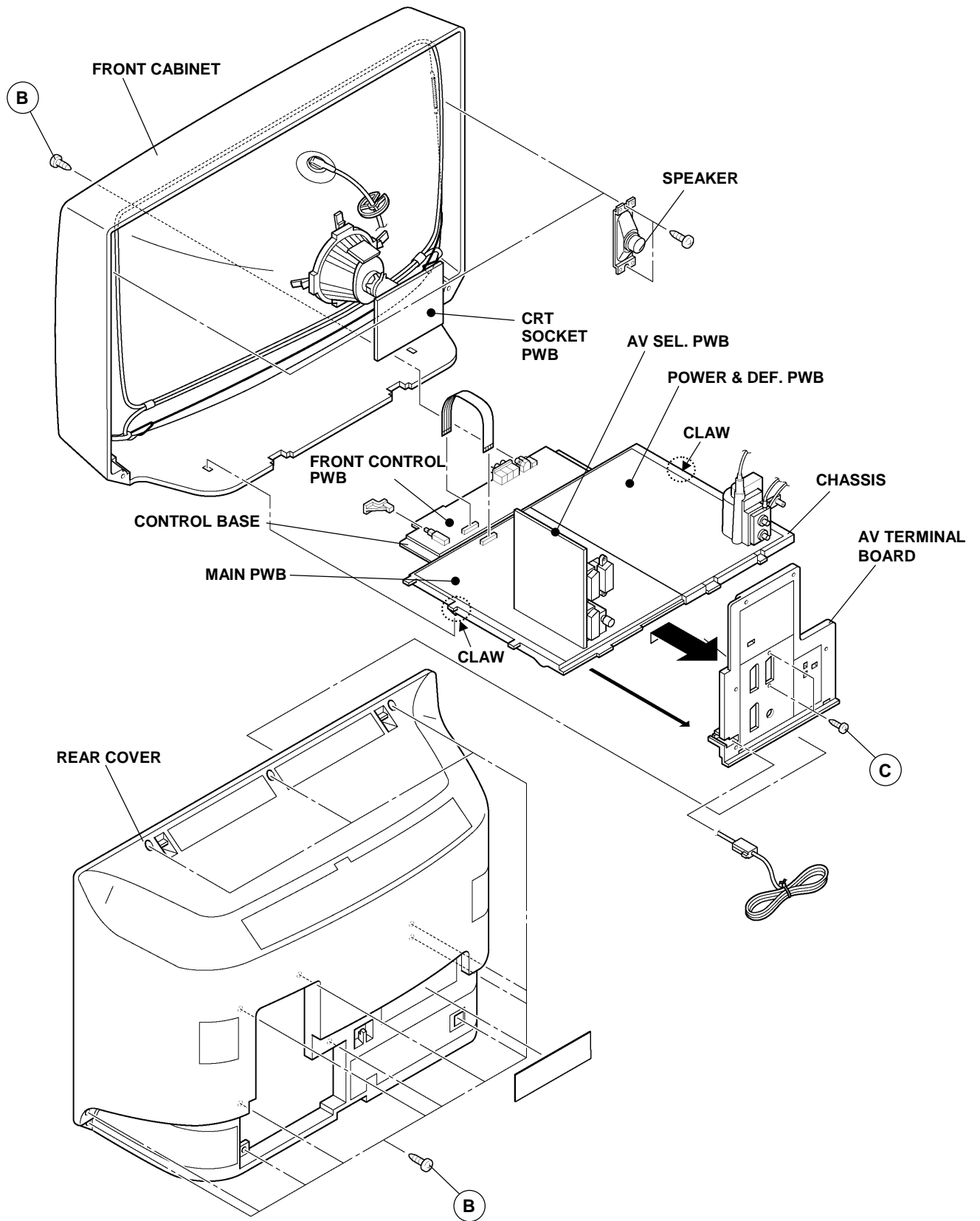

Fig. 1

DISASSEMBLY PROCEDURE (24" Model)

REMOVING THE REAR COVER

1. Unplug the power cord.
2. Remove the 9 screws marked "A" as shown in the Fig. 3.
3. Withdraw the rear cover toward you.

REMOVING THE CHASSIS

- After removing the rear cover.
1. Slightly raise the both sides of the chassis by hand and remove the two claws under the both sides of the chassis from the front cabinet.
 2. Withdraw the chassis backward.
(If necessary, take off the wire clamp, connectors etc.)

REMOVING THE AV TERMINAL BOARD

- After removing the rear cover.
1. Remove the 2 screws marked "B" as shown in the Fig. 3.
 2. Remove the claws marked "C" under the CHASSIS as shown in Fig. 4.
 3. While raising the claw marked "D", remove the top of the AV TERMINAL BOARD slightly in the direction of arrow "E" as shown in Fig. 4.

REMOVING THE SPEAKER

- After removing the rear cover.
1. Remove the 2 screws marked "F" as shown in Fig. 3.
 2. Follow the same steps when removing the other hand speaker.

CHECKING THE PW BOARD

- To check the back side of the PW Board.
- 1) Pull out the chassis. (Refer to REMOVING THE CHASSIS).
 - 2) Erect the chassis vertically so that you can easily check the back side of the PW Board.

[CAUTION]

- When erecting the chassis, be careful so that there will be no contacting with other PW Board.
- Before turning on power, make sure that the wire connector is properly connected.
- When conducting a check with power supplied, be sure to confirm that the CRT EARTH WIRE (BRAIDED ASS'Y) is connected to the CRT SOCKET PW board.

WIRE CLAMPING AND CABLE TYING

1. Be sure to clamp the wire.
2. Never remove the cable tie used for tying the wires together.
Should it be inadvertently removed, be sure to tie the wires with a new cable tie.

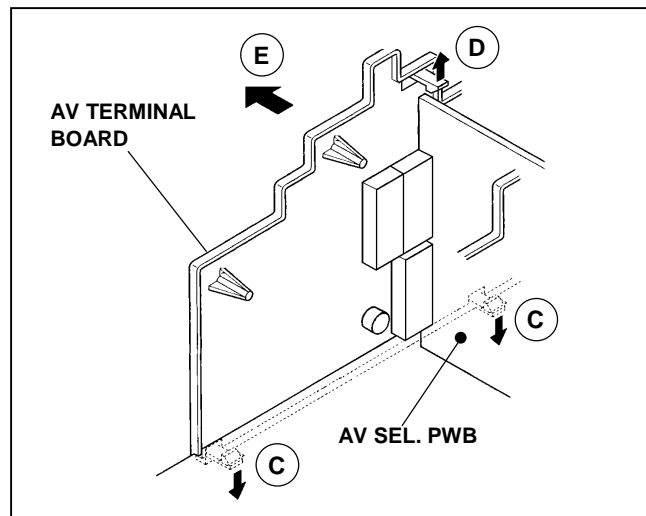

Fig. 4

(24" Model)

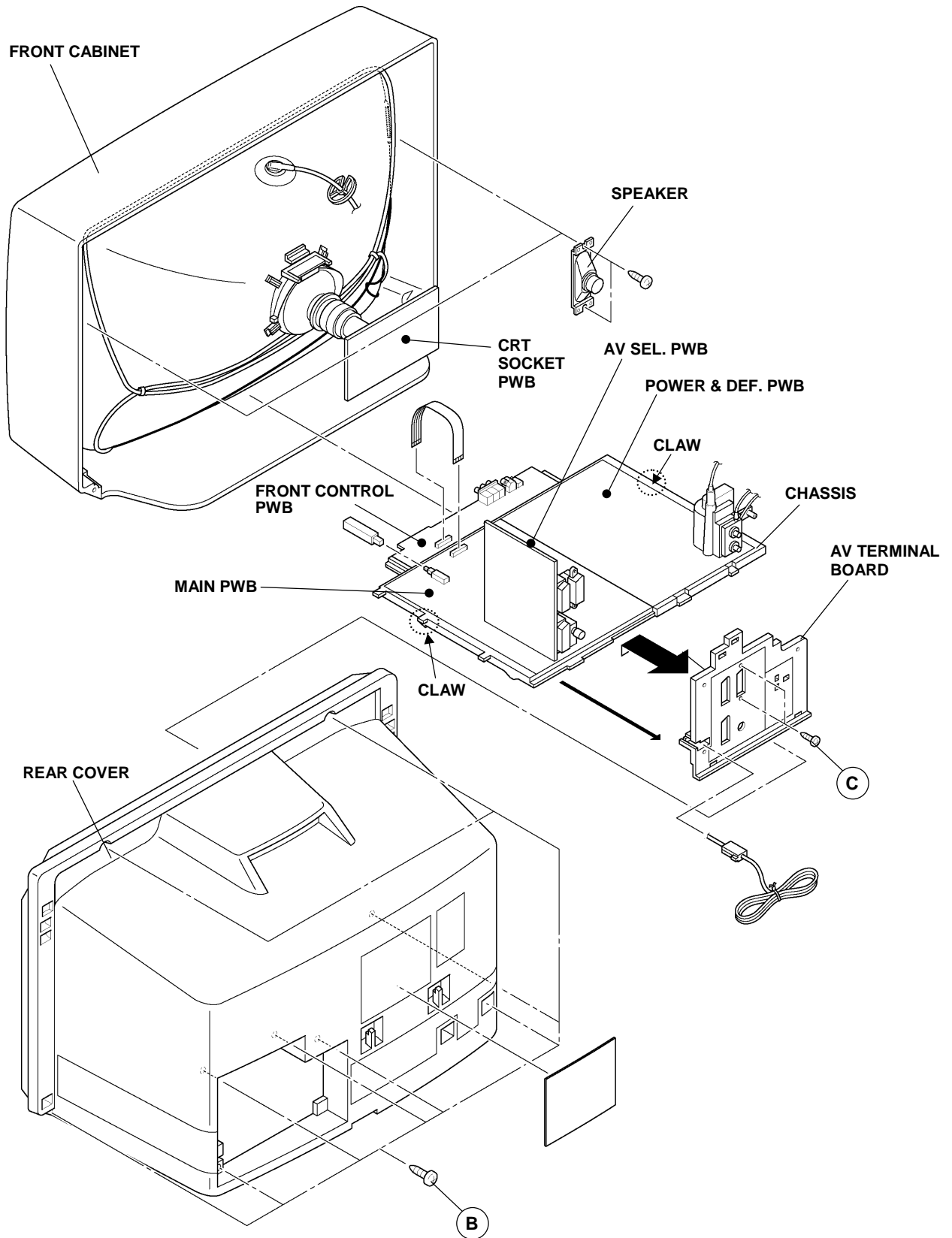

Fig. 3

REMOVING THE CRT

- * Replacement of the CRT should be performed by 2 or more persons.
- After removing the cover, chassis etc.,
 1. Putting the CRT change table on soft cloth, the CRT change table should also be covered with such soft cloth (shown in Fig.5).
 2. While keeping the surface of CRT down, mount the TV set on the CRT change table balanced well as shown in Fig.6.
 3. Remove 4 screws marked by arrows with a box type screw driver as shown in Fig.6.
- Since the cabinet will drop when screws have been removed, be sure to support the cabinet with hands.
- 4. After 4 screws have been removed, put the cabinet slowly on cloth (At this time, be carefully so as not to damage the front surface of the cabinet) shown in Fig.7.
- The CRT should be assembled according to the opposite sequence of its dismantling steps.
- * The CRT change table should preferably be smaller than the CRT surface, and its height be about 35cm.

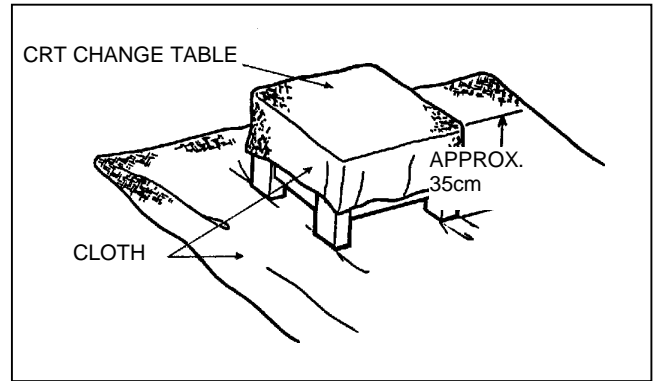

Fig. 5

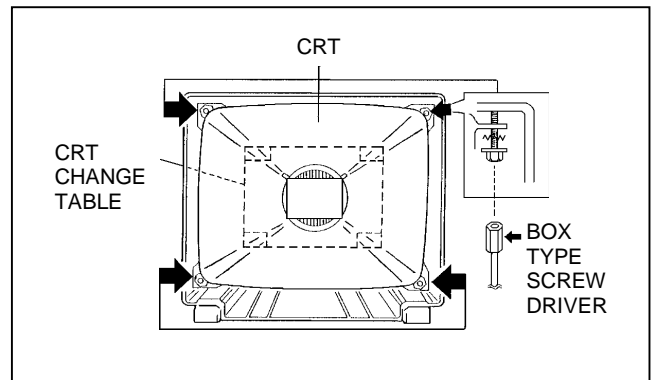

Fig. 6

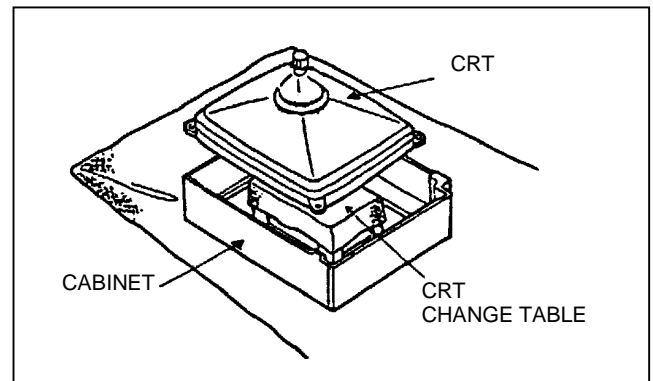

Fig. 7

COATING OF SILICON GREASE FOR ELECTRICAL INSULATION ON THE CRT ANODE CAP SECTION.

- Subsequent to replacement of the CRT and HV transformer or repair of the anode cap, etc. by dismantling them, be sure to coat silicon grease for electrical insulation as shown in Fig.8.
- Wipe around the anode button with clean and dry cloth. (Fig.8)
- Coat silicon grease on the section around the anode button. At this time, take care so that any silicon greases do not stick to the anode button. (Fig.9)

★ Silicon grease product No. KS - 650N

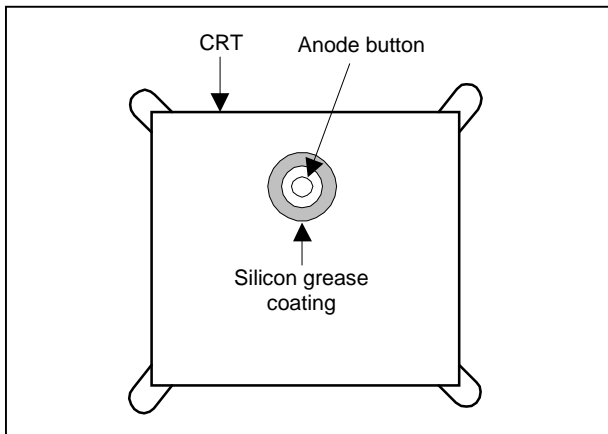

Fig. 8

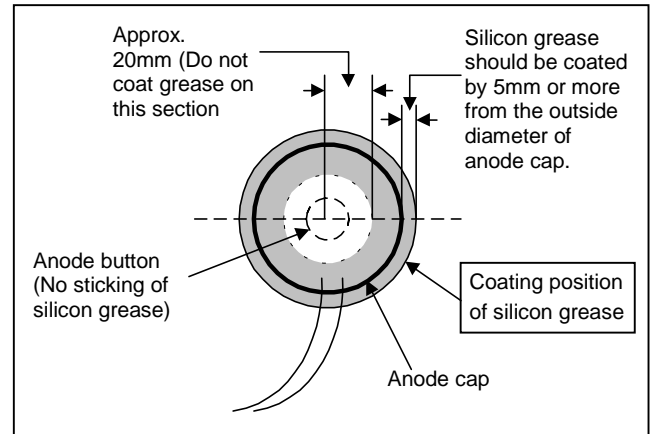

Fig. 9

REPLACEMENT OF MEMORY ICs

1. Memory ICs

This TV use memory ICs. In the memory ICs, there are memorized data for correctly operating the video and deflection circuits. When replacing memory ICs, be sure to use ICs written with the initial values of data.

2. Procedure for replacing memory ICs

PROCEDURE
<p>(1) Power off Switch the power off and unplug the power cord from the outlet.</p>
<p>(2) Replace ICs. Be sure to use memory ICs written with the initial data values.</p>
<p>(3) Power on Plug the power cord into the outlet and switch the power on.</p>
<p>(4) Check and set SYSTEM CONSTANT SET: * It must not adjust without signal. 1) Press the INFORMATION key and the MUTING key of the REMOTE CONTROL UNIT simultaneously. 2) The SERVICE MENU screen of Fig. 1 will be displayed. 3) While the SERVICE MENU is displayed, press the INFORMATION key and MUTING key simultaneously, and the SYSTEM CONSTANT SET screen of Fig. 2 will be displayed. 4) Check the setting values of the SYSTEM CONSTANT SET of Table 1. If the value is different, select the setting item with the FUNCTION UP/DOWN key, and set the correct value with the FUNCTION +/- key. 5) Press the MENU key to memorize the setting value. 6) Press the INFORMATION key twice, and return to the normal screen.</p>
<p>(5) Setting of receive channels Set the receive channel. For setting, refer to the OPERATING INSTRUCTIONS.</p>
<p>(6) User settings Check the user setting values of Table 2, and if setting value is different, set the correct value. For setting, refer to the OPERATING INSTRUCTIONS.</p>
<p>(7) Setting of SERVICE MENU Verify the setting items of the SERVICE MENU of Table 3, and reset where necessary. For setting, refer to the SERVICE ADJUSTMENTS.</p>

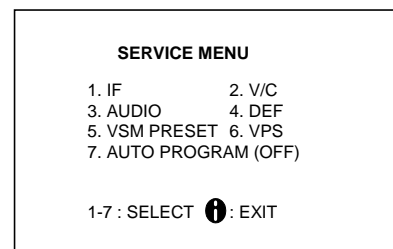

Fig.1

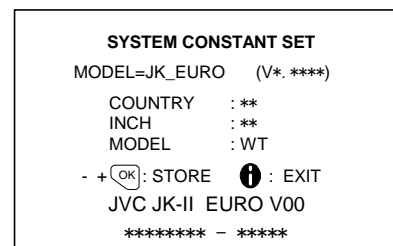

Fig.2

NAME OF REMOTE CONTROL KEY

Names of key	key
INFORMATION	
MUTING	
MENU	
FUNCTION UP/DOWN	
FUNCTION +/-	

AV28WT5EPS AV24WT5EPS
 AV28WT5EIS AV24WT5EIS
 AV28WT5EKS AV24WT5EKS

SETTING VALUES OF SYSTEM CONSTANT SET (TABLE 1)

Setting item	Setting content	Setting value		
		AV28WT5EPS	AV28WT5EIS	AV28WT5EKS
		AV24WT5EPS	AV24WT5EIS	AV24WT5EKS
COUNTRY		EP	IR	EK
INCH		28	28	28
		24	24	24
MODEL		WT	←	←

USER SETTING VALUES (TABLE 2)

PICTURE SETTING		EXT SETTING	
TINT CONTRAST BRIGHT SHARP COLOUR ECO MODE	COOL REFER to VSM PRESET OFF	ID S-IN DUBBING	BLANK BLANK EXT-1→EXT-2
PICTURE FEATURES		FEATURES	
AUTO VNR COLOUR SYSTEM 4:3 AUTO ASPECT	AUTO TV : According to preset CH EXT : AUTO PANORAMIC	SLEEP TIMER BLUE BACK CHILD LOCK DECODER (EXT-2)	OFF ON ID : No.**** ALL CH OFF OFF
SOUND SETTING		INSTALL	
STEREO / I · II BASS TREBLE BALANCE HYPER SOUND		LANGUAGE EDIT/MANUAL DEMO	ENGLISH PRESET CH only The others : BLANK OFF

SERVICE MENU SETTING ITEMS (TABLE 3)

Setting item	Setting value	Setting item	Setting value
1. IF	VCO	4. DEF.	1. V-SHIFT 2. V-SIZE 3. SUBTITLE 4. H-CENT 5. H-SIZE 6. EW-PIN 7. TRAPEZ 8. EW. COR. L 9. EW. COR. H 10. V. S-COR 11. V- LIN 12. H-BLK-R 13. H-BLK-L 14. V-EHT 15. H-EHT 16. EHT-GAIN
2. V / C	1. CUT OFF 2. DRIVE 3. BRIGHT 4. CONT. 5. COLOUR 6. HUE 7. BLACK OFFSET (Only SECAM) 8. SHARP 9. PURITY	5. VSM PRESET	1. BRIGHT 2. CONT. 3. COLOUR 4. SHARP 5. HUE 6. R DRIVE 7. B DRIVE
1. AUDIO (Do not adjust)	1. CONC LIMIT 2. A2 ID THR 3. ALC 4. BASS 5. TREBLE	6. VPS (Do not adjust)	VPS PDC
		7. AUTO PROGRAM (Do not adjust)	ON / OFF

SERVICE ADJUSTMENTS

BEFORE STARTING SERVICE ADJUSTMENT

1. There are 2 ways of adjusting this TV: One is with the REMOTE CONTROL UNIT and the other is the conventional method using adjustment parts and components.
2. The setting (adjustment) using the REMOTE CONTROL UNIT is made on the basis of the initial setting values. The setting values which adjust the screen to the optimum condition can be different from the initial setting values.
3. Make sure that connection is correctly made to AC power source.
4. Turn on the power of the TV and measuring instrument for warming up for at least 30 minutes before starting adjustment.
5. If the receive or input signal is not specified, use the most appropriate signal for adjustment.
6. Never touch parts (such as variable resistors, transformers and condensers) not shown in the adjustment items of this service adjustment.
7. Preparation for adjustment (presetting):
 Unless otherwise specified in the adjustment items, preset the following functions with the REMOTE CONTROL UNIT:
 - Setting position

PICTURE MODE (VSM)	NORMAL
SLEEP TIMER	OFF
BALANCE	CENTER
ECO	OFF
ZOOM	PANORAMIC

MEASURING INSTRUMENT AND FIXTURES

1. DC voltmeter (or digital voltmeter)
2. Oscilloscope
3. Signal generator (Pattern generator) [PAL / SECAM / NTSC]
4. Remote control unit

ADJUSTMENT ITEMS

- B1 power supply check.
- Adjustment of FOCUS.
- IF circuit adjustment.
- VSM preset adjust setting.
- VIDEO / CHROMA circuit adjustment.
- DEFLECTION circuit adjustment.
- H. BLANKING ADJUSTMENT.
- AUDIO circuit adjustment. (Do not adjust)

ADJUSTMENT LOCATIONS (1)

(28" Model)

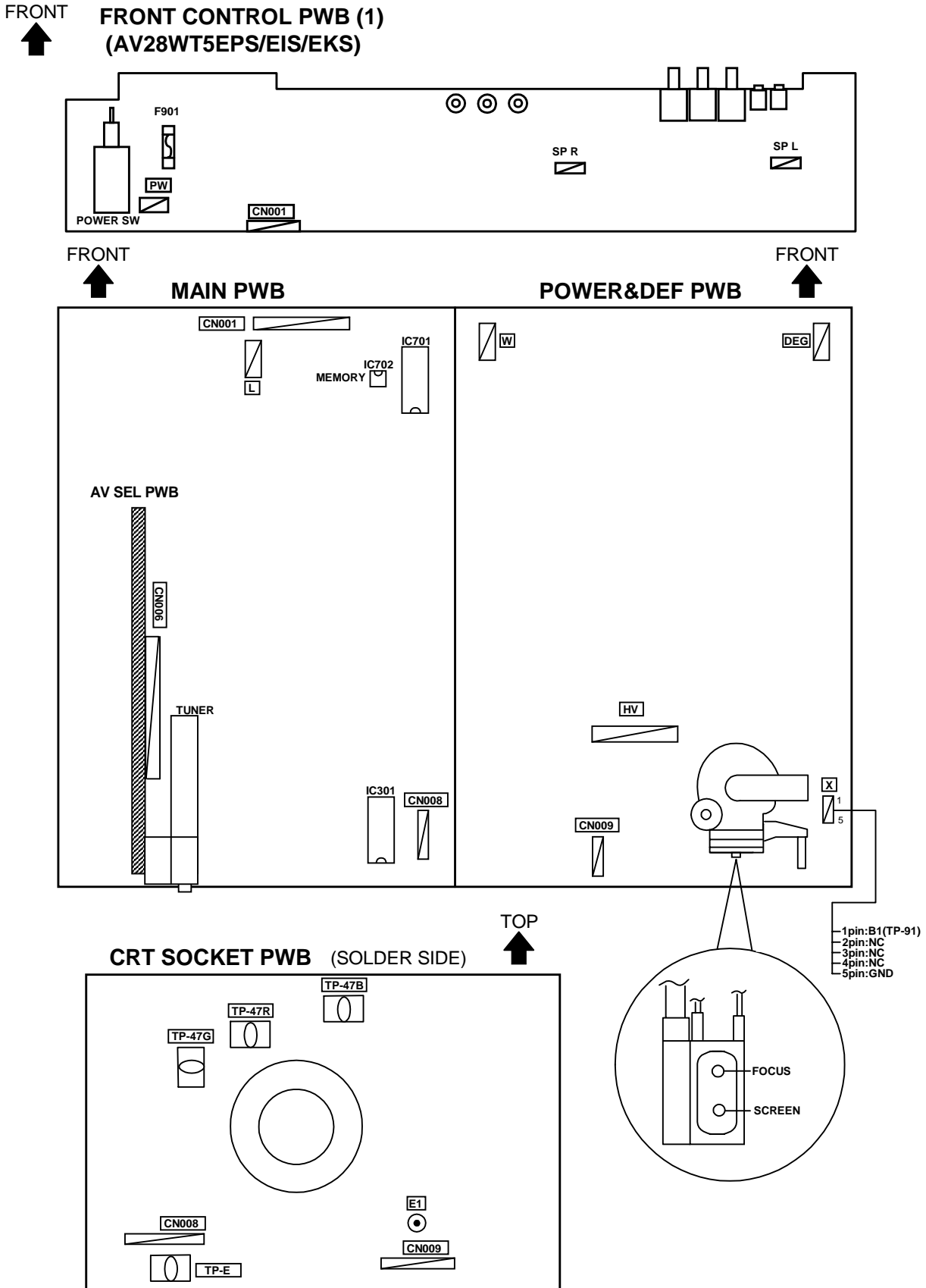

ADJUSTMENT LOCATIONS (2)

(24" Model)

FRONT

FRONT CONTROL PWB (1)
 (AV24WT5EPS/EIS/EKS)

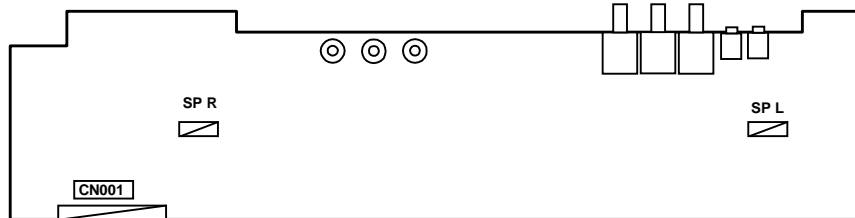

FRONT

MAIN PWB

POWER&DEF PWB

FRONT

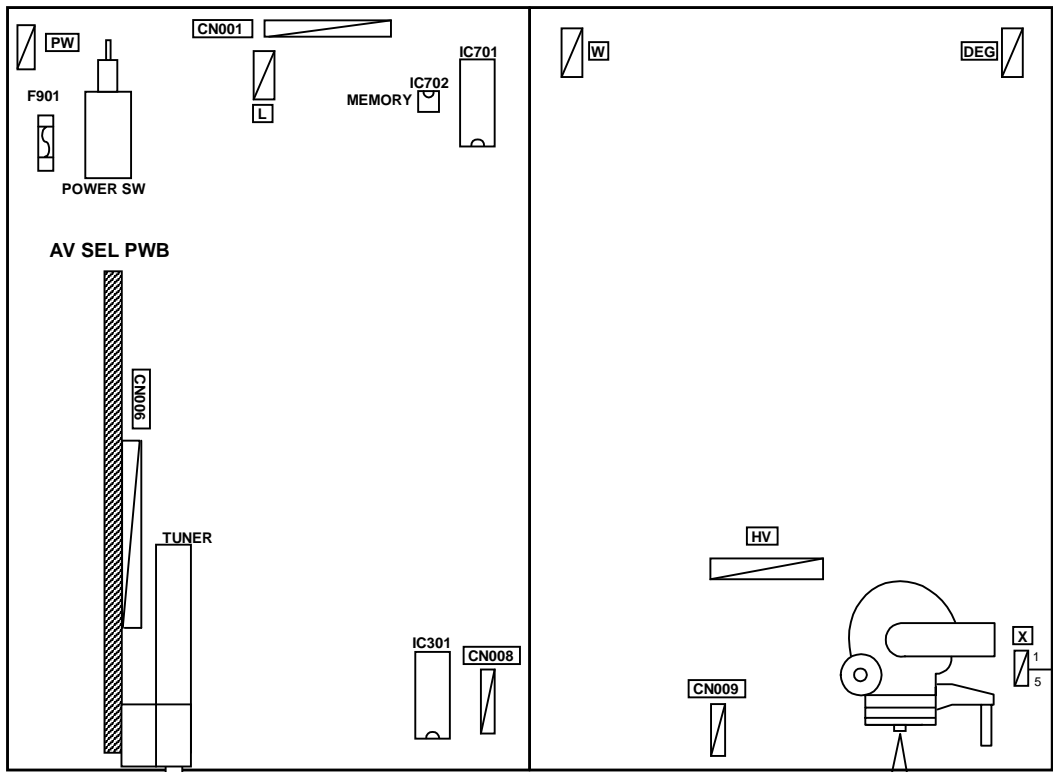
TOP

CRT SOCKET PWB (SOLDER SIDE)

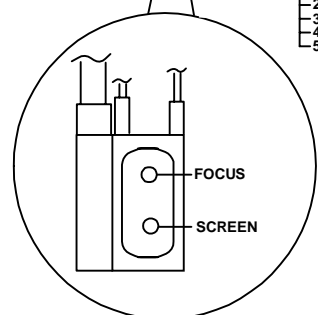
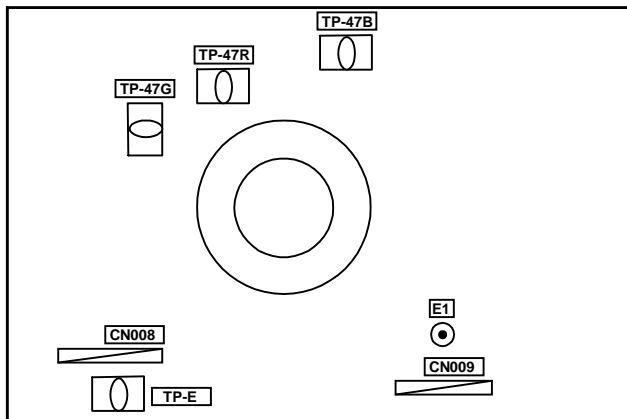

- 1pin: B1(TP-91)
- 2pin: NC
- 3pin: NC
- 4pin: NC
- 5pin: GND

BASIC OPERATION SERVICE MENU

1. TOOL OF SERVICE MENU OPERATION

Operate the SERVICE MENU with the REMOTE CONTROL UNIT.

2. SERVICE MENU ITEMS

With the SERVICE MENU, various settings (adjustments) can be made, and they are broadly classified in the following items of settings (adjustments):

- (1) **1. IF** This mode adjusts the setting values of the IF circuit.
- (2) **2.V/C** This mode adjusts the setting values of the VIDEO / CHROMA circuit.
- (3) **3.AUDIO** This mode adjusts the setting values of the multiplicity SOUND circuit.
- (4) **4.DEF** This mode adjusts the setting values of the DEFLECTION circuit for each aspect mode given below.

REGULAR	(50/60Hz)
PANORAMIC	(50/60Hz)
14:9 ZOOM	(50/60Hz)
16:9 ZOOM	(50/60Hz)
SUB TITLE	(50/60Hz)
FULL	(50/60Hz)
- (5) **5.VSM PRESET** This mode adjusts the initial setting values of COOL,NOMAL and WARM.
(VSM : Video Status Memory)
- (6) **6.VPS** This mode shows the monitor of the VPS and PDC. **(Do not adjust)**.
(VPS : Video Program System, PDC : Program Delivery Code)
- (7) **7.AUTO PROGRAM** By turning the power switch on, you can get the state of AUTO PROGRAM. **(Do not adjust)**

3. BASIC OPERATION OF SERVICE MENU

(1) How to enter SERVICE MENU

Press the INFORMATION key and the MUTING key of the REMOTE CONTROL UNIT simultaneously, and the SERVICE MENU screen of Fig. 1 will be displayed.

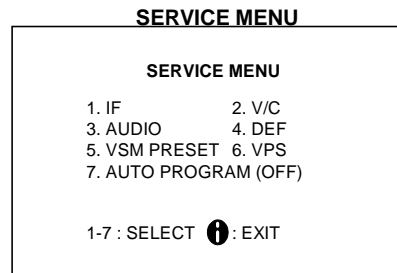

Fig.1

(2) Selection of SUB MENU SCREEN

Press one of keys 1~7 of the REMOTE CONTROL UNIT and select the SUB MENU SCREEN (See Fig. 3), form the SERVICE MENU.

SERVICE MENU → SUB MENU

- 1. IF
- 2. V / C
- 3. AUDIO
- 4. DEF.
- 5. VSM PRESET
- 6. VPS
- 7. AUTO PROGRAM

NEME OF REMOTE CONTOROL KEY

Names of key	key
INFORMATION	
MUTING	
MENU	
FUNCTION UP/DOWN	
FUNCTION -/+	

Fig.2

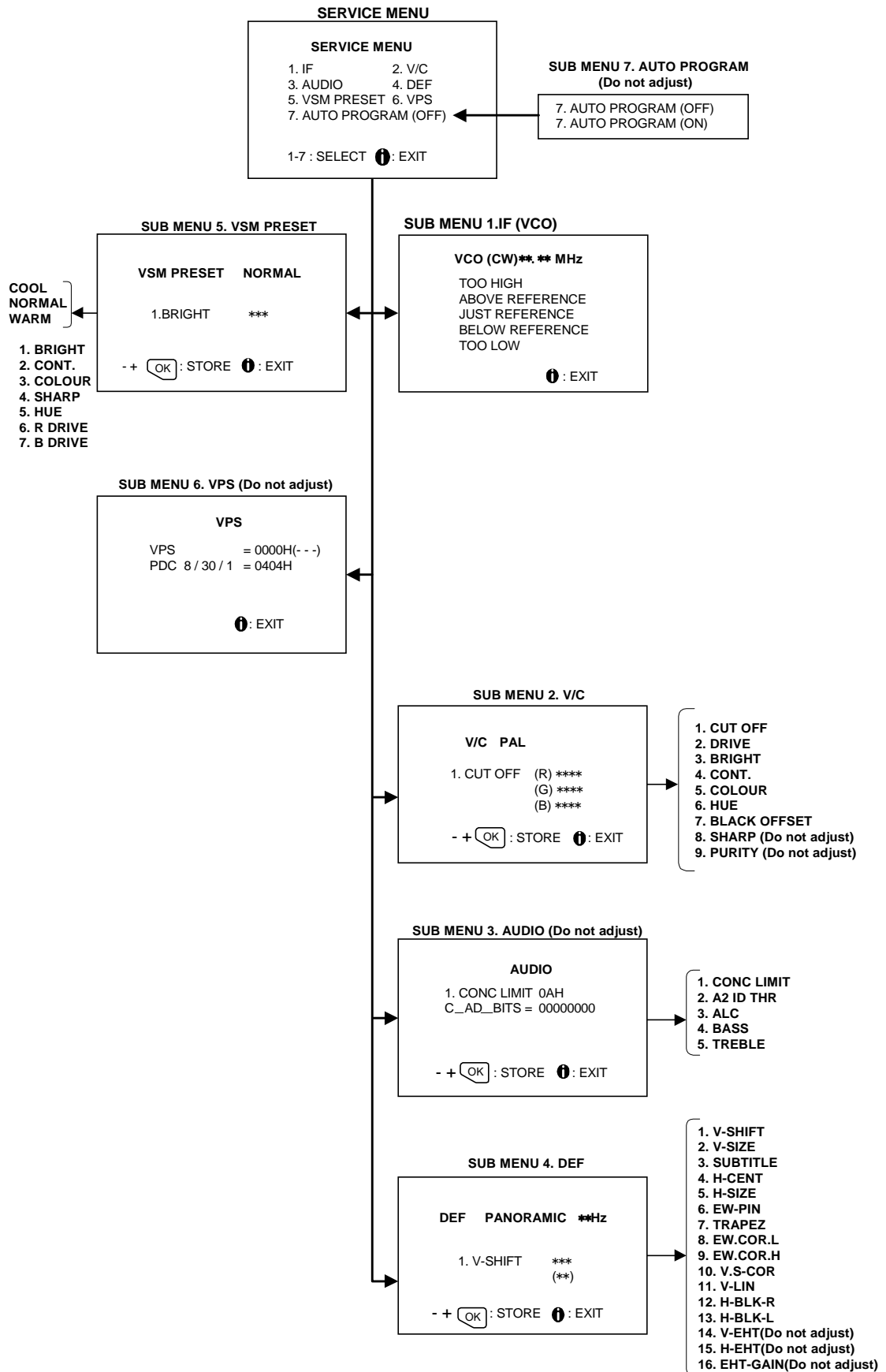

Fig. 3 SUB MENU SCREEN

AV28WT5EPS AV24WT5EPS
AV28WT5EIS AV24WT5EIS
AV28WT5EKS AV24WT5EKS

(3) **Method of Setting**

1) Method of Setting **1.IF**

[VCO]

- ① 1 Key Select 1.IF.
- ② The VCO (CW) screen will be displayed in yellow when the AFC voltage is at a certain level and in blue when it is at other levels.
- ③ INFORMATION Key Return to the SERVICE MENU screen.

2) Method of setting **2.V/C, 3.AUDIO, 4.DEF** and **5.VSM PRESET**.

- ① 2~5 Key Select one from **2. V/C, 3. AUDIO, 4. DEF** and **5. VSM PRESET**.
- ② FUNCTION UP/DOWN Key Select setting items.
- ③ FUNCTION +/- Set (adjust) the setting values of the setting items.
(Use the number keys of the REMOTE CONTROL UNIT for setting of WHITE BALANE.
For the setting, refer to each item concerned.)
- ④ MENU Key Memorize the setting value.
(Before storing the setting values in memory, do not press the CH, TV, POWER ON / OFF key -
if you do, the values will not be stored in memory.)
- ⑤ INFORMATION Key Return to the **SERVICE MENU** screen.

3) Method of setting **6.VPS** and **7.AUTO PROGRAM**.

6.VPS This mode displayed monitor of VPS systems. **(Do not adjust)**

7.AUTO PROGRAM When the MAIN POWER is turned on with the state of AUTO PROGRAM ON, you get a mode that initializes every existing set value including language selection. Because this mode is set at the factory upon completion of the adjustment, you need not to use it for service. **(Do not adjust in this mode.)**

(4) **Release of SERVICE MENU**

- 1) After completing the setting, return to the SERVICE MENU, then again press the INFORMATION key.

ADJUSTMENTS

CHECK ITEM

Item	Measuring instrument	Test point	Adjustment part	Description
Check of B1 Power Supply	Signal Generator DC voltmeter Remote Control unit	TP-91(B1) TP-E(↵) [X connector on POWER DEF PWB]		<ol style="list-style-type: none"> 1. Receive a any broadcast. 2. Push the "ZOOM" key and select the FULL mode. 3. Select 2. V/C from the SERVICE MENU. 4. Select 1. CUT OFF with Function UP / DOWN key. 5. Show one horizontal line with the 1 key. 6. Turn the SCREEN VR, the whole black screen display. 7. Connect a DC voltmeter to TP-91(B1) and TP-E(↵). 8. Make sure that the voltage is DC144.5 ±2.0V. 9. Readjust the SCREEN VR to appear the horizontal line faintly, and cancel the horizontal line to press the 2 key.
Check of High Voltage	Signal Generator DC volunter Remote Control unit	CRT anode Chassis GND		<ol style="list-style-type: none"> 1. Receive a any broadcast. 2. Push the "ZOOM" key and select the FULL mode. 3. Select 2. V/C from the SERVICE MENU. 4. Select 1. CUT OFF with Function UP / DOWN key. 5. Show one horizontal line with the 1 key. 6. Turn the SCREEN VR, the whole black screen display. 7. Connect a DC voltmeter to CRT ANODE and chassis GND. 8. Make sure that the voltage is DC 30.0kV ^{+1kV} _{-1.5kV}. 9. Readjust the SCREEN VR to appear the horizontal line faintly, and connect the horizontal line to press 2 key.

ADJUSTMENT OF FOCUS

Item	Measuring instrument	Test point	Adjustment part	Description
Adjustment of FOCUS	Signal generator		FOCUS VR [In FBT]	<ol style="list-style-type: none"> 1. Receive a cross-hatch signal. Select FULL mode. 2. While watching the screen, adjust the FOCUS VR to make the vertical and horizontal lines as fine and sharp as possible. 3. Make sure that when the screen is darkened, the lines remain in good focus.

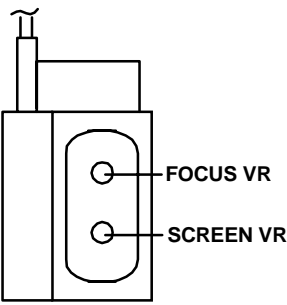

IF CIRCUIT ADJUSTMENT

Item	Measuring instrument	Test point	Adjustment part	Description
Adjustment of VCO	Remote control unit			<ul style="list-style-type: none"> ● Under normal conditions, no adjustment is required. 1. Receive any broadcast. 2. Select 1.IF from the SERVICE MENU. 3. Check the characters colour of the JUST REFERENCE displayed to yellow.

VCO(CW) ***. ** MHz ← fv

TOO HIGH

ABOVE REFERENCE

JUST REFERENCE ← YELLOW

BELOW REFERENCE

TOO LOW

i : EXIT

VSM PRESET ADJUST SETTING

Item	Measuring instrument	Test point	Adjustment part	Description
Setting of VSM PRESET	Remote control unit		<ol style="list-style-type: none"> 1. BRIGHT 2. CONT. 3. COLOUR 4. SHARP 5. HUE 6. R DRIVE 7. B DRIVE 	<ol style="list-style-type: none"> 1. Select 5.VSM PRESET from the SERVICE MENU. 2. Select COOL with the MENU key of the remote control unit. 1. Adjust the FUNCTION UP/DOWN and -/+ key to bring the set values of 1.BRIGHT ~ 7. B DRIVE to the values shown in the table. 4. Press the MENU key and memorize the set value. 5. Respectively select the VSM PRESET mode for NORMAL and WARM, and make similar adjustment as in 3 above. 6. Press the MENU key and memorize the set value. * Refer to OPERATING INSTRUCTIONS for the PICTURE MODE.

VSM preset mode	COOL	NORMAL	WARM
Setting item			
1. BRIGHT SETTING VALUE	+0	+0	+0
2. CONT. SETTING VALUE	+12	+10	+2
3. COLOUR SETTING VALUE	+6	+0	-2
4. SHARP SETTING VALUE	+0	+0	-2
5. HUE SETTING VALUE	+0	+0	+0
6. R DRIVE SETTING VALUE	-20	+0	+16
7. B DRIVE SETTING VALUE	+23	+0	-13

SETTING VALUES OF VSM PRESET

VIDEO / CHROMA CIRCUIT ADJUSTMENT

The setting (adjustment) using the REMOTE CONTROL UNIT is made on the basis of the initial setting values.
 The setting values which adjust the screen to the optimum condition can be different from the initial setting values.

Setting Item (Adjustment Item)		Initial setting value
1. CUTOFF	R	-100
	G	-100
	B	-100
2. DRIVE	R	+0
	B	+0
3. BRIGHT		+0
4. CONT.		-10

Colour system Setting item		Initial setting value		
		PAL	SECAM	NTSC 3.58 NTSC 4.43
5. COLOUR		+14	+0	+8
6. HUE		—	—	+2
7. BLACK OFFSET (SECAM)	R-Y	—	+0	—
	B-Y	—	+0	—
8. SHARP (Do not adjust)	28"Model	-7	←	←
	24"Model	-10	←	←
9. PURITY (Do not adjust)		OFF	←	←

Item	Measuring instrument	Test point	Adjustment part	Description
Adjustment of WHITE BALANCE (Low Light)	Signal generator		1.CUT OFF (R)*** (G)*** (B)***	<ul style="list-style-type: none"> Set the PICTURE MODE to NORMAL. Receive a black and white signal (colour off). Select 2. V/C from the SERVICE MENU. Select 1.CUT OFF with the FUNCTION UP/DOWN key. Push the "ZOOM" key and select the "PANORAMIC" mode. Show one horizontal line with the 1 key. Gradually turn the SCREEN VR from the left end to the right direction to bring one of the red, green or blue colour faintly visible. Press 4~9 key, and bring out the other 2 colours and make one horizontal line visible in white. Turn the SCREEN VR and bring one white horizontal line faintly visible. Press 2 key, turn off 1.CUT OFF screen. Press the MENU key and memorize the set value.
	Remote control unit		SCREEN VR [In FBT]	

Remote Control Unit

H.LINE ON	H.LINE OFF	
①	②	③
R CUTOFF▲	G CUTOFF▲	B CUTOFF▲
④	⑤	⑥
R CUTOFF▼	G CUTOFF▼	B CUTOFF▼
⑦	⑧	⑨

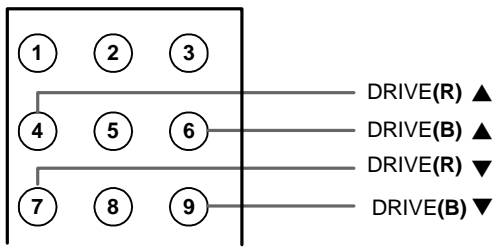
Item	Measuring instrument	Test point	Adjustment part	Description
Adjustment of WHITE BALANCE (High Light)	Signal generator Remote control unit		2.DRIVE (R) * * * (B) * * *	<ul style="list-style-type: none"> ● The adjustment for Low Light WHITE BALANCE should be finished. ● Set the PICTURE MODE to NORMAL. <ol style="list-style-type: none"> 1. Receive a black and white signal (colour off). 2. Select 2.V/C from the SERVICE MENU. 3. Select 2.DRIVE with the FUNCTION UP/DOWN key. 4. Change the screen colour to white with 4 key or 7 key (Drive of Red), 6 key or 9 key (Drive of Blue). 5. Press the MENU key, and memorize the set values.
<div style="border: 1px solid black; padding: 5px; width: fit-content; margin: 0 auto;"> REMOTE CONTROL UNIT </div> 				
Adjustment of SUB BRIGHT	Remote control unit		3.BRIGHT	<ol style="list-style-type: none"> 1. Receive any broadcast. 2. Select 2.V/C from the SERVICE MENU. 3. Select 3.BRIGHT with the FUNCTION UP/DOWN key. 4. Set the initial setting value with the FUNCTION +/- key. 5. If the brightness is not the best with the initial setting value, make fine adjustment until you get the best brightness. 6. Press the MENU key and memorize the set value.
Adjustment of SUB CONT.	Remote control unit		4.CONT.	<ol style="list-style-type: none"> 1. Receive any broadcast. 2. Select 2.V/C from the SERVICE MENU. 3. Select 4.CONT with the FUNCTION UP/DOWN key. 4. Set the initial setting value with the FUNCTION - / + key. 5. If the contrast is not the best with the initial setting value, make fine adjustment until you get the best contrast. 6. Press the MENU key and memorize the set value.

Item	Measuring instrument	Test point	Adjustment part	Description
Adjustment of SUB COLOUR I	Remote control unit		5.COLOUR (PAL~NTSC)	[Method of adjustment without measuring instrument]
			PAL COLOUR	(PAL COLOUR) 1. Receive PAL broadcast. 2. Select 2.V/C from the SERVICE MENU. 3. Select 5.COLOUR with the FUNCTION UP/DOWN key. 4. Set the initial setting value for PAL COLOUR with the FUNCTION - or + key. 5. If the colour is not the best with the initial set value, make fine adjustment until you get the best colour. 6. Press the MENU key and memorize the set value.
			SECAM COLOUR { Only AV28WT5EPS AV24WT5EPS }	(SECAM COLOUR) 1. Receive a SECAM broadcast. 2. Make fine adjustment of SECAM COLOUR in the same manner as for above.
			NTSC COLOUR	(NTSC 3.58 COLOUR) 1. Input a NTSC 3.58MHz COMPOSITE VIDEO signal from the EXT terminal. 2. Make similar fine adjustment of NTSC 3.58 COLOUR in the same manner as for above.
				(NTSC 4.43 COLOUR) 1. When NTSC 3.58 is set, NTSC 4.43 will be automatically set at the respective values.

Item	Measuring instrument	Test point	Adjustment part	Description						
Adjustment of SUB COLOUR II	Signal generator Oscilloscope Remote control unit	TP-47B TP-E(↕) [CRT SOCKET PWB]	5.COLOUR (PAL~NTSC)	[Method of adjustment using measuring instrument]						
			PAL COLOUR	(PAL COLOUR) 1. Receive a PAL full field colour bar signal (75% white). 2. Select 2.V/C from the SERVICE MENU. 3. Select 5.COLOUR with the FUNCTION UP/DOWN key. 4. Set the initial setting value of PAL COLOUR with the FUNCTION - or + key. 5. Connect the oscilloscope between TP-47B and TP-E(↕). 6. Adjust PAL COLOUR and bring the value of (A) in the illustration to the values as shown given billow (Voltage difference between white (W) and blue (B)). 7. Press the MENU key and memorize the setting value. <table border="1" style="margin: 10px auto;"> <thead> <tr> <th>MODEL</th> <th>VOLTAGE (W-B)</th> </tr> </thead> <tbody> <tr> <td>28" model</td> <td>+6V</td> </tr> <tr> <td>24" model</td> <td>+4V</td> </tr> </tbody> </table>	MODEL	VOLTAGE (W-B)	28" model	+6V	24" model	+4V
			MODEL	VOLTAGE (W-B)						
28" model	+6V									
24" model	+4V									
SECAM COLOUR [Only AV28WT5EPS AV24WT5EPS]	(SECAM COLOUR) 1. Receive a SECAM full field colour bar signal(75% white). 2. Set the initial setting value of SECAM COLOUR with the FUNCTION -/+ key. 3. Adjust SECAM COLOUR and bring the value of (A) in the illustration to the values as shown given billow (Voltage difference between white (W) and blue (B)). 4. Press the MENU key and memorize the setting value. <table border="1" style="margin: 10px auto;"> <thead> <tr> <th>MODEL</th> <th>VOLTAGE (W-B)</th> </tr> </thead> <tbody> <tr> <td>28" model</td> <td>+6V</td> </tr> <tr> <td>24" model</td> <td>+4V</td> </tr> </tbody> </table>	MODEL	VOLTAGE (W-B)	28" model	+6V	24" model	+4V			
MODEL	VOLTAGE (W-B)									
28" model	+6V									
24" model	+4V									
NTSC COLOUR	(NTSC 3.58 COLOUR) 1. Input a NTSC 3.58MHz COMPOSITE VIDEO signal (full field colour bar with 75% white) from the EXT terminal. 2. Set the initial setting value of NTSC 3.58 COLOUR with the FUNCTION -/+ key. 3. Adjust NTSC 3.58 COLOUR and bring the value of (A) of the illustration to 0V w-b. 4. Press the MENU key and memorize the setting value. <table border="1" style="margin: 10px auto;"> <thead> <tr> <th>MODEL</th> <th>VOLTAGE (W-B)</th> </tr> </thead> <tbody> <tr> <td>28" model</td> <td>+6V</td> </tr> <tr> <td>24" model</td> <td>+4V</td> </tr> </tbody> </table>	MODEL	VOLTAGE (W-B)	28" model	+6V	24" model	+4V			
MODEL	VOLTAGE (W-B)									
28" model	+6V									
24" model	+4V									
				(NTSC 4.43 COLOUR) 1. When NTSC 3.58 is set, NTSC 4.43 will be automatically set at the respective values.						

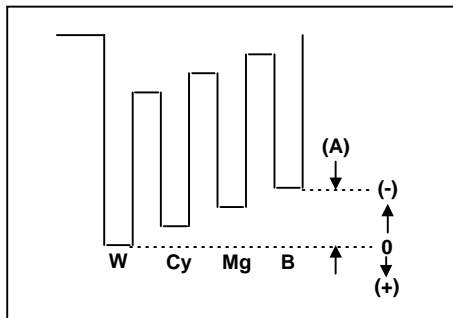

Item	Measuring instrument	Test point	Adjustment part	Description
Adjustment of SUB HUE I	Remote control unit		6.HUE	[Method of adjustment without measuring instrument]
			NTSC 3.58 HUE	[NTSC 3.58 HUE] 1. Input a NTSC 3.58MHz COMPOSITE VIDEO signal (full field colour bar with 75% white) from the EXT terminal. 2. Select 2.V/C from the SERVICE MENU. 3. Select 6. HUE with the FUNCTION UP/DOWN key. 4. Set the initial setting value of NTSC 3.58 HUE with the FUNCTION +/- key. 5. If you cannot get the best hue with the initial setting value, make fine adjustment until you get the best hue. 6. Press the MENU key and memorize the set value.
			NTSC 4.43 HUE	[NTSC 4.43 HUE] 1. When NTSC 3.58 is set, NTSC 4.43 will be automatically set at the respective values.
Adjustment of SUB HUE II	Signal generator	TP-47B TP-E(↗) [CRT SOCKET PWB]	6. HUE	[Method of adjustment using measuring instrument]
	Oscilloscope		NTSC 3.58 HUE	[NTSC 3.58 HUE] 1. Input a NTSC 3.58MHz COMPOSITE VIDEO signal (full field colour bar with 75% white) from the EXT terminal. 2. Select 2.V/C from the SERVICE MENU. 3. Select 6. HUE with the FUNCTION UP/DOWN key. 4. Set the initial setting value of NTSC 3.58 HUE with the FUNCTION - or + key. 5. Connect the oscilloscope between TP-47B and TP-E(↗) 6. Adjust NTSC 3.58 HUE to bring the value of (B) in the illustration to -4V (voltage difference between white (W) and magenta (Mg)). 7. Press the MENU key and memorize the setting value
	Remote control unit		NTSC 4.43 HUE	[NTSC 4.43 HUE] 1. When NTSC 3.58 is set, NTSC 4.43 will be automatically set at the respective values.

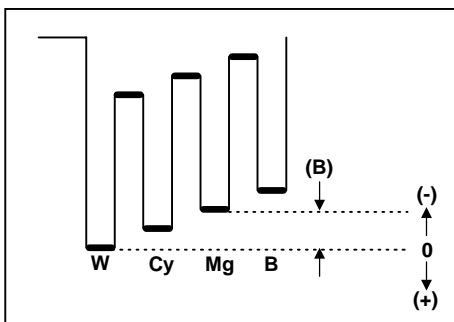

[Only AV28WT5EPS / AV24WT5EPS]

Item	Measuring instrument	Test point	Adjustment part	Description
Adjustment of BLACK OFFSET (SECAM) I	Remote control unit		7. BLACK OFFSET (R-Y) *** (B-Y) ***	<p>[Method of adjustment without measuring instrument]</p> <ol style="list-style-type: none"> 1. Receive a SECAM broadcast. 2. Select 2. V/C from SERVICE MENU. 3. Select 7. BLACK OFFSET with the FUNCTION UP/DOWN key. 4. Set the initial setting value for BLACK OFFSET (R-Y) and (B-Y) with 4 and 7 or 6 and 9 keys of the remote control. 5. If the picture is not the best with the initial setting value, make fine adjustment until you get the best picture. 6. Press the MENU key and memorize the setting value.
Adjustment of BLACK OFFSET (SECAM) II	Signal generator Oscilloscope Remote control unit	35 PIN (R-Y) 36 PIN (B-Y) IC-301 ON MAIN PWB	7. BLACK OFFSET (R-Y) *** (B-Y) ***	<p>[Method of adjustment using measuring instrument]</p> <ol style="list-style-type: none"> 1. Receive a SECAM COLOUR bar signal (full field colour bar 75% white). 2. Select 2. V/C from SERVICE MENU. 3. Select 7. BLACK OFFSET with the FUNCTION UP/DOWN key. 4. Connect the oscilloscope between 35 pin of IC-301 and TP-E (↗). 5. By using 4 and 7 keys of the remote control, adjust the BLACK OFFSET (R-Y) so that it becomes the waveform changes from (a) to (b) shown in the figure. 6. Connect the oscilloscope between 36 pin of IC-301 and TP-E. 7. By using 6 and 9 keys of the remote control, adjust the BLACK OFFSET (B-Y) so that it becomes the waveform changes from (c) to (d) shown in the figure. 8. If the picture is not the best with the adjusted picture, make fine adjustment until you get the best picture. 9. Press the MENU key and memorize the setting value.
<p>[R-Y]</p>				
<p>[B-Y]</p>				

DEFLECTION CIRCUIT ADJUSTMENT

There are 7 modes of the adjustment (1) 50Hz mode (①PANORAMIC ②FULL ③REGULAR ④14:9 ZOOM ⑤16:9 ZOOM ⑥16:9 ZOOM SUB TITLE), (2) 60Hz mode (each aspect mode) depending upon the kind of signals (vertical frequency 50Hz / 60Hz).

- The adjustment using the remote control unit is made on the basis of the initial setting values.
- When the 50Hz PANORAMIC mode has been established, the setting of other modes will be done automatically. However, if the picture quality has not been optimized, adjust each mode again, respectively.
- The setting values which adjust the screen to the optimum condition can be different from the initial setting values.

Initial setting value (1/2) (28" Model)

Setting item	Adjustment name	Initial setting value							
		PANORAMIC		14:9 ZOOM		16:9 ZOOM		16:9 ZOOM SUB TITLE	
		50Hz	60Hz	50Hz	60Hz	50Hz	60Hz	50Hz	60Hz
1. V-SHIFT	Vertical center	+2	-1	+0	+0	+0	+0	+0	+0
2. V-SIZE	Vertical height	+6	-3	+16	+15	+36	+34	+38	+36
3. SUBTITLE	SUBTITLE BOTTOM Vertical Linearity	-8	+0	+0	+0	+0	+0	+11	+15
4. H-CENT	Horizontal center	-8	+4	+0	+1	+0	+0	+0	+0
5. H-SIZE	Horizontal width	+10	+0	-13	-14	-6	-6	-6	-6
6. EW-PIN	Side pin correction	-23	+0	-1	-1	-1	-1	-1	-1
7. TRAPEZ	Trapezoidal distortion correction	+2	-1	-1	+0	-1	+0	-1	+0
8. EW.COR.L	CORNER PIN correction Low side	+0	+0	+0	+0	+0	+0	+0	+0
9. EW.COR.H	CORNER PIN correction High side	+0	+0	+0	+0	+0	+0	+0	+0
10.V.S-COR	Vertical height correction	+4	+0	+0	+0	+0	+0	+4	+0
11.V-LIN	Vertical Linearity	-1	+0	+0	+0	+1	+0	+0	+0
12.H-BLK-R	BLANKING POSITION of Right side	+0	+0	+118	+119	+0	+0	+0	+0
13.H-BLK-L	BLANKING POSITION of Left side	+0	+0	+28	+24	+0	+0	+0	+0
14.V-EHT (Do not adjust)	V size correction level caused by EHT change	-4	+0	+0	+0	+0	+0	+0	+0
15.H-EHT (Do not adjust)	H size correction level caused by EHT change	-3	+0	+0	+0	+0	+0	+0	+0
16.EHT-GAIN (Do not adjust)	Size correction gain caused by EHT change	+0	+0	+0	+0	+0	+0	+0	+0

Initial setting value (2/2)

Setting item	Adjustment name	Initial setting value			
		FULL		REGULAR	
		50Hz	60Hz	50Hz	60Hz
1. V-SHIFT	Vertical center	-1	+0	+0	+0
2. V-SIZE	Vertical height	-6	-6	-3	-3
3. SUBTITLE	SUBTITLE BOTTOM Vertical Linearity	+0	+0	+0	+0
4. H-CENT	Horizontal center	+0	+0	+1	+1
5. H-SIZE	Horizontal width	-6	-6	-22	-23
6. EW-PIN	Side pin correction	-1	+0	+0	+0
7. TRAPEZ	Trapezoidal distortion correction	+0	+0	-1	-1
8. EW.COR.L	CORNER PIN correction Low side	+0	+0	+0	+0
9. EW.COR.H	CORNER PIN correction High side	+0	+0	+0	+0
10.V.S-COR	Vertical height correction	+0	+0	+0	+0
11.V-LIN	Vertical Linearity	+0	+0	+0	+0
12.H-BLK-R	BLANKING POSITION of Right side	+0	+0	+118	+119
13.H-BLK-L	BLANKING POSITION of Left side	+0	+0	+31	+25
14.V-EHT (Do not adjust)	Vsize correction level caused by EHT change	+0	+0	+0	+0
15.H-EHT (Do not adjust)	Hsize correction level caused by EHT change	+0	+0	+0	+0
16.EHT-GAIN (Do not adjust)	Size correction gain caused by EHT change	+0	+0	+0	+0

Initial setting value (1/2) (24" Model)

Setting item	Adjustment name	Initial setting value							
		PANORAMIC		14:9 ZOOM		16:9 ZOOM		16:9 ZOOM SUB TITLE	
		50Hz	60Hz	50Hz	60Hz	50Hz	60Hz	50Hz	60Hz
1. V-SHIFT	Vertical center	-10	-1	+0	+0	+0	+0	+1	+0
2. V-SIZE	Vertical height	+5	-3	+14	+14	+36	+35	+33	+35
3. SUBTITLE	SUBTITLE BOTTOM Vertical Linearity	-8	+0	+0	+0	+0	+0	+9	+12
4. H-CENT	Horizontal center	-7	+5	+0	+1	+0	+0	+0	+0
5. H-SIZE	Horizontal width	+14	+0	-17	-16	-10	-11	-10	-10
6. EW-PIN	Side pin correction	-4	+1	-3	-4	-3	-2	-4	-5
7. TRAPEZ	Trapezoidal distortion correction	+1	-1	-1	-1	-1	-2	-1	-1
8. EW.COR.L	CORNER PIN correction Low side	+0	+0	+0	+0	+0	+0	+0	+0
9. EW.COR.H	CORNER PIN correction High side	+0	+0	+0	+0	+0	-1	+1	+0
10.V.S-COR	Vertical height correction	-11	+0	-0	-0	+0	+0	+0	+0
11.V-LIN	Vertical Linearity	+0	+0	+0	+0	+0	+0	-2	-1
12.H-BLK-R	BLANKING POSITION of Right side	+0	+0	+116	+118	+0	+0	+0	+0
13.H-BLK-L	BLANKING POSITION of Left side	+0	+0	+32	+24	+0	+0	+0	+0
14.V-EHT (Do not adjust)	Vsize correction level caused by EHT change	-4	+0	+0	+0	+0	+0	+0	+0
15.H-EHT (Do not adjust)	Hsize correction level caused by EHT change	-3	+0	+0	+0	+0	+0	+0	+0
16.EHT-GAIN (Do not adjust)	Size correction gain caused by EHT change	+0	+0	+0	+0	+0	+0	+0	+0

Initial setting value (2/2)

Setting item	Adjustment name	Initial setting value			
		FULL		REGULAR	
		50Hz	60Hz	50Hz	60Hz
1. V-SHIFT	Vertical center	+0	+0	+0	+0
2. V-SIZE	Vertical height	-6	-5	-5	-3
3. SUBTITLE	SUBTITLE BOTTOM Vertical Linearity	+0	+0	+0	+0
4. H-CENT	Horizontal center	+0	+0	+0	+1
5. H-SIZE	Horizontal width	-10	-11	-30	-30
6. EW-PIN	Side pin correction	-2	-3	-2	-3
7. TRAPEZ	Trapezoidal distortion correction	+0	+0	+0	-1
8. EW.COR.L	CORNER PIN correction Low side	+0	+0	+0	+0
9. EW.COR.H	CORNER PIN correction High side	+0	+0	+0	+0
10.V.S-COR	Vertical height correction	+0	+0	+0	+0
11.V-LIN	Vertical Linearity	+0	+0	+0	+0
12.H-BLK-R	BLANKING POSITION of Right side	+0	+0	+116	+113
13.H-BLK-L	BLANKING POSITION of Left side	+0	+0	+33	+24
14.V-EHT (Do not adjust)	Vsize correction level caused by EHT change	+0	+0	+0	+0
15.H-EHT (Do not adjust)	Hsize correction level caused by EHT change	+0	+0	+0	+0
16.EHT-GAIN (Do not adjust)	Size correction gain caused by EHT change	+0	+0	+0	+0

Item	Measuring instrument	Test point	Adjustment part	Description
Adjustment of V-SHIFT	Signal generator Remote control unit		1.V- SHIFT	<p>[50Hz PANORAMIC mode]</p> <ol style="list-style-type: none"> 1. Receive a circle pattern signal of vertical frequency 50Hz. 2. Select 4.DEF from the SERVICE MENU. 3. Select 1.V-SHIFT with the FUNCTION UP/DOWN key. 4. Adjust V-SHIFT to make A = B. 5. Press the MENU key and memorize the set value. <p>* For JK chassis Set all data except for "PANORAMIC" to "0". Adjust V.CENTER of other aspects with "PANORAMIC" mode while also taking their positions into consideration. If you want to obtain horizontal lines with less noise on the screen, adjust V.LIN instead of "PANORAMIC" mode.</p>
Adjustment of V-SIZE & SUBTITLE			2.V-SIZE 3.SUBTITLE	<ol style="list-style-type: none"> 6. Receive a cross-hatch signal. 7. Select 2.V-SIZE and set the initial setting value. 8. Adjust V-SIZE and make sure that the vertical screen size of the picture size is in the bellow table. 9. Press the MENU key and memorize the set value. 10. When adjust the [SUBTITLE], select "3.SUBTITLE" and adjust to under part of picture size. 11. Input a NTSC VIDEO signal (60Hz) from the EXT terminal, and make sure that the vertical screen size is in the table below. 12. Press the MENU key and memorize the set value.

ASPECT MODE	PANORAMIC	14 : 9 ZOOM	16 : 9 ZOOM	16 : 9 ZOOM SUB TITLE	FULL	REGULAR
SCREEN TOP	87%	80%	70%	70%	92%	92%
SCREEN BOTTOM	87%	80%	70%	83%	92%	92%

[SCREEN SIZE]

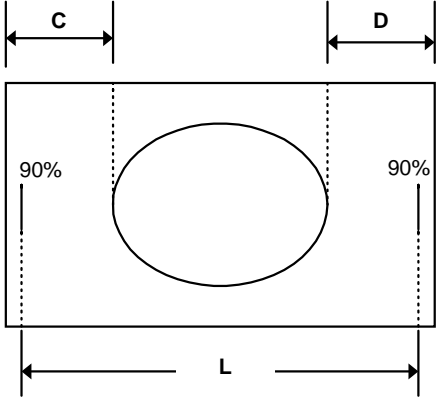
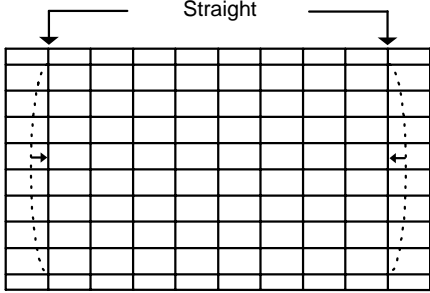
Item	Measuring instrument	Test point	Adjustment part	Description																												
Adjustment of H.CENTER 			4.H-CENT.	6. Receive a circle pattern signal. 7. Select 4.H-CENT and set the initial setting value. 8. Adjust H-CENT to make C=D. 9. Press the MENU key and memorize the set value.																												
Adjustment of H.SIZE			5.H-SIZE	10. Receive a circle pattern signal. 11. Select 5.H-SIZE and set the initial setting value. 12. Adjust H-SIZE and make sure that the horizontal screen size of the picture size is in the below table. 13. Press the MENU key and memorize the set value. ※ The numeric of the REGULAR and 14:9 ZOOM modes are shown the length of the 90% horizontal size position(L) as shown in the figure above. 14. Input a NTSC VIDEO signal (60Hz) from the EXT terminal, and make sure that the horizontal screen size of the each ASPECT mode is in the below table. 15. Press the MENU key and memorize the set value.																												
<table border="1"> <thead> <tr> <th colspan="2">ASPECT MODE</th> <th>PANORAMIC</th> <th>14:9 ZOOM</th> <th>16:9 ZOOM</th> <th>16:9 ZOOM SUB TITLE</th> <th>FULL</th> <th>REGULAR</th> </tr> </thead> <tbody> <tr> <td rowspan="2">H SIZE</td> <td rowspan="2">28"</td> <td>PAL=95%</td> <td rowspan="2">L=495mm</td> <td rowspan="2">92%</td> <td rowspan="2">92%</td> <td rowspan="2">92%</td> <td rowspan="2">L=440mm</td> </tr> <tr> <td>NTSC=94%</td> </tr> <tr> <td rowspan="2"></td> <td rowspan="2">24"</td> <td>PAL=95%</td> <td rowspan="2">L=425mm</td> <td rowspan="2">92%</td> <td rowspan="2">92%</td> <td rowspan="2">92%</td> <td rowspan="2">L=380mm</td> </tr> <tr> <td>NTSC=94%</td> </tr> </tbody> </table>							ASPECT MODE		PANORAMIC	14:9 ZOOM	16:9 ZOOM	16:9 ZOOM SUB TITLE	FULL	REGULAR	H SIZE	28"	PAL=95%	L=495mm	92%	92%	92%	L=440mm	NTSC=94%		24"	PAL=95%	L=425mm	92%	92%	92%	L=380mm	NTSC=94%
ASPECT MODE		PANORAMIC	14:9 ZOOM	16:9 ZOOM	16:9 ZOOM SUB TITLE	FULL	REGULAR																									
H SIZE	28"	PAL=95%	L=495mm	92%	92%	92%	L=440mm																									
		NTSC=94%																														
	24"	PAL=95%	L=425mm	92%	92%	92%	L=380mm																									
		NTSC=94%																														
[SCREEN SIZE]																																
Adjustment of EW-PIN			6.EW-PIN	16. Select 6.EW-PIN and set the initial setting value 17. Adjust EW-PIN and make the 2nd.vertical lines at the left and right edges of the screen straight. Also make sure that the 3rd vertical lines are straight. 18. Press the MENU key and memorize the set value.																												
																																

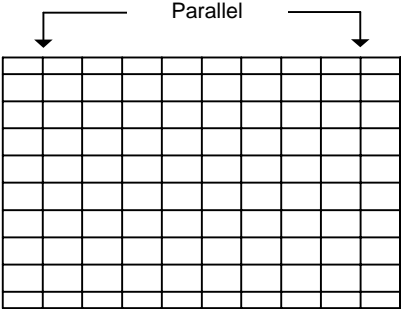
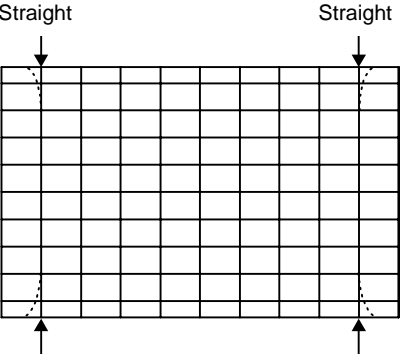
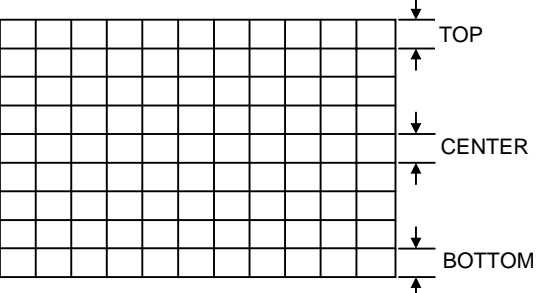
Item	Measuring instrument	Test point	Adjustment part	Description
Adjustment of TRAPEZ	Signal generator Remote control unit		7.TRAPEZ	19. Receive a cross-hatch signal. 20. Select 7.TRAPEZ with the FUNCTION UP/DOWN key. 21. Set the initial setting value of TRAPEZ with the FUNCTION - or + key. 22. Adjust TRAPEZ and bring the VERTICAL lines at the right and left edges of the screen parallel . 23. Press the MENU key and memorize the set value.
				
Adjustment of EW. COR. L/H	Signal generator Remote control unit		8.EW. COR. L 9.EW. COR. H	24. Select 8.EW. COR. L with the FUNCTION UP / DOWN key. 25. Set the initial setting value of EW. COR. L with the FUNCTION - or + key. 26. Adjust EW. COR. L, and bring the straight line at the low corner. 27. Select 9.EW. COR. H with the FUNCTION UP / DOWN key. 28. Set the initial setting value of EW. COR. H with the FUNCTION - or + key. 29. Adjust EW. COR. H, and bring the straight line at the upper corner. 30. Press the MENU key and memorize the set value.
				
Adjustment of V-S.CR & V.LINEARITY			10. V-S.CR 11. V-LIN	<ul style="list-style-type: none"> ● When the vertical linearity has been deteriorated remarkably, perform the following steps. 31. Receive a cross-hatch signal. 32. Select 11.V-LIN with the FUNCTION UP/DOWN key. 33. Set the initial setting value of 11.V-LIN with the FUNCTION - / + key. 34. Select 10.V-S.COR with the FUNCTION UP / DOWN key. 35. Set the initial setting value of 10.V-S.COR with the FUNCTION - / + key. 36. Adjust 11.V-LIN and 10.V-S.COR so that the spaces of each line on TOP, CENTER and BOTTOM become uniform. <p>NOTE :Do not adjust "PANORAMIC" & "16 : 9 ZOOM SUBTITLE" mode.</p> <ul style="list-style-type: none"> * For JK chassis On account of CRT (ITC), set V-S.COR except for "PANORAMIC" mode to the minimum. When adjusting "PANORAMIC" mode, slightly expand the space at the CENTER while taking the circularity at the CENTER into consideration.
				

AV-28WT5EKS AV-24WT5EKS
 AV-28WT5EPS AV-24WT5EPS
 AV-28WT5EIS AV-24WT5EIS

Item	Measuring instrument	Test point	Adjustment part	Description
				At first the adjustment in 50Hz-PANORAMIC mode should be done, then the data for the other zoom mode is corrected in the respective value at the same time. And confirm the deflection adjustment initial setting value in 60Hz(NTSC EXT mode) PANORAMIC mode. If the adjustment in 50Hz each zoom mode has been done and stored, the data for the same aspect modes in 60Hz is corrected in the respective value. Only the data for the other aspect mode in 60Hz is corrected for itself.

H. BLANKING ADJUSTMENT

Item	Measuring instrument	Test point	Adjustment part	Description
Adjustment of H.BLANKING			H.BLK Capacitor [On MAIN PWB]	<ol style="list-style-type: none"> 1. Receive the PAL circle pattern signal. 2. Select 4.DEF from the SERVICE MENU. 3. Select the aspect [14:9 ZOOM] mode. 4. Select 12.H-BLK-R with the FUNCTION UP/DOWN key and adjust H-BLANKING so that 92% of the picture on the right side is displayed. 5. Select 13.H-BLK-L with the FUNCTION UP/DOWN key and adjust H-BLANKING so that 92% of the picture on the left side is displayed. 6. Press the MENU key and memorize the set value. 7. Select the aspect [REGULAR] mode. 8. Select 12.H-BLK-R with the FUNCTION UP/DOWN key and adjust H'.BLANKING so that 92% of the picture on the right side is displayed. 9. Select 13.H-BLK-L with the FUNCTION UP/DOWN key and adjust H-BLANKING so that 92% of the picture on the left side is displayed. 10. Press the MENU key and memorize the set value.

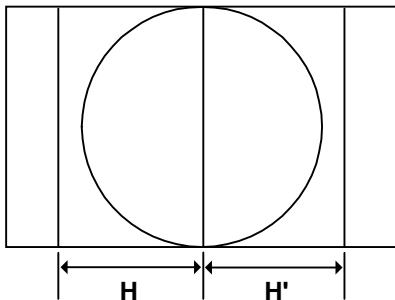

AUDIO CIRCUIT ADJUSTMENT

- Do not touch 3.AUDIO(1. CONC LIMIT, 2. A2 ID THR, 3. ALC, 4. BASS, 5. TREBLE) of the SERVICE MENU as it requires no adjustment.

3. AUDIO

Setting item	Variable range	fixed value
1. CONC LIMIT(<i>Do not adjust</i>)	00H ~ FFH	0AH
2. A2 ID THR(<i>Do not adjust</i>)	00H ~ FFH	19H
3. ALC (<i>Do not adjust</i>)	20MSEC → 2SEC → 4SEC → 8SEC	_____
4. BASS (<i>Do not adjust</i>)	-17 ~ +17	+0
5. TREBLE (<i>Do not adjust</i>)	-17 ~ +17	+0

AV-28WT5EKS AV-24WT5EKS
AV-28WT5EPS AV-24WT5EPS
AV-28WT5EIS AV-24WT5EIS

JVC

VICTOR COMPANY OF JAPAN, LIMITED

HOME AV NETWORK BUSINESS UNIT 1106 Heta, Iwai-city, Ibaraki-prefecture, 306-0698, Japan

AV28WT5EPS-U #4 AV24WT5EPS-U #4
AV28WT5EIS-U #4 AV24WT5EIS-U #4
AV28WT5EKS-U #3 AV24WT5EKS-U #3



Printed in Japan
VP 0101
DP2051